

Veillance Flux, Vixels, Veillons: An information-bearing extramissive formulation of sensing, to measure surveillance and sousveillance

Ryan Janzen and Steve Mann

Department of Electrical and Computer Engineering, University of Toronto

Abstract—

The word “surveillance” comes from the French word “veillance” which means “watching” and the French prefix “sur”, which means “from above”. Thus “surveillance” means “to watch from above” (e.g. guards watching over prisoners or police watching over a city through a city-wide surveillance camera network). The closest purely English word is “oversight”.

A more recent phenomenon, *sousveillance* (“undersight”) refers to the less hierarchical and more rhizomic veillance of social networking, distributed cloud-based computing, and body-worn technologies. *Sousveillance* forms a reciprocal power balance with *surveillance*, both being understood in the context of not just technology, but also complex human social and political relationships.

In this paper we derive a precise theoretical and mathematical framework to understand, interpret, quantify, and classify “veillance” (“watching”) as to its directionality (i.e. *surveillance* versus *sousveillance*).

While veillance can occur in a variety of sensory modalities, such as auditory *sur/sousveillance*, *dataveillance*, etc., we will focus especially on optical (visual) veillance. We define new physical concepts: the *veillon*, the *vixel*, and the *veillance vector field*, to provide insight into the measurement and demarcation of *surveillance* and *sousveillance* and their interplay.

I. INTRODUCTION

Surveillance is a French word that means “watching” (“veillance”) from above (“sur”). Examples include guards watching prisoners, police watching over citizens, etc.. More generally, surveillance is the observation or recording of an activity by an inanimate object (machine), or by a person not participating in the activity, i.e. by cameras borne by non-human objects [1], [2], [3]. Surveillance often consists of

English	French
to see	voir
to look (at)	regarder
to watch	veiller
watching (monitoring)	veillance
watching over (oversight)	surveillance
to oversee (to watch from above)	surveiller
over (from above)	sur
under (from below)	sous
“undersight” (to watch from below)	sousveillance

TABLE I. THE VEILLANCES (SURVEILLANCE AND SOUSVEILLANCE)

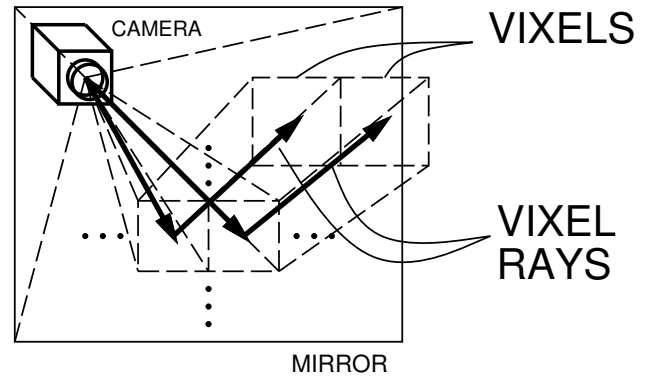

Fig. 1. Veillance flux and a veillance field are proposed in this work, and can be thought of as an aggregate spatial integral of bidirectional reflectance distribution functions (BRDF). To begin, we reverse the direction light is normally understood, so we can develop an **information-bearing** concept of light propagation. **Vixels**, and **vixel rays**, can be understood as being *emitted* from a camera, as with ray tracing in computer graphics, where rays of light are modeled as emanating from the eye or from a camera. These rays obey the usual rules of optics (e.g. reflection in a mirror) but with time reversal (e.g. opposite direction of travel to photons). In this figure, vixel rays are represented along the centroid of the vixel’s cross-sectional area.

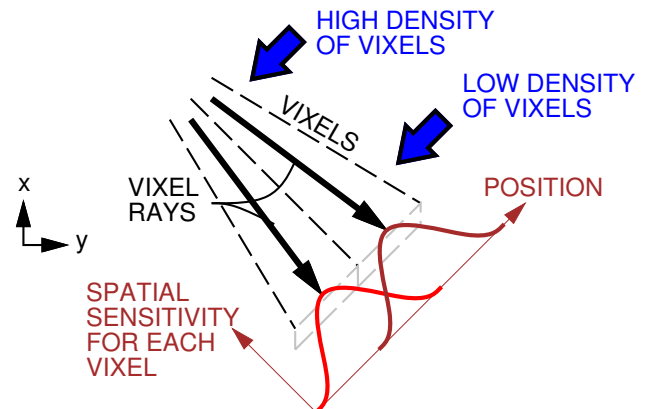

Fig. 2. Vixels with fuzzy boundaries due to overlapping spatial sensitivity. (A small amount of blurring because of camera optics can still preserve uniqueness of each vixel.) Vixel ray density will be used to form the veillance vector field.

cameras affixed to property, i.e. real-estate: either buildings (e.g. mounted to inside or outside walls or ceilings), or to land (e.g. mounted to lamp posts, poles, and the like) [1], [4], [5], [6], [7], [8]. In this sense, surveillance is typically an action initiated by a property owner.

We use the term *veillance*, more broadly, to describe a deliberate action of watching, observing or sensing, that does not necessarily originate “from above” (“sur”).

Another form of veillance is *sousveillance*, which means

“to watch from below” [1], [6], [8], [7], [2], [9], [4], [5]. The etymology of “sousveillance” derives from the French prefix “sous” which means “under” or “from below”. Table I shows the etymology of surveillance (oversight), sousveillance (undersight) and veillance (sight/watching).

Whereas surveillance is often done by means of cameras affixed to large entities (e.g. buildings and land), sousveillance is often done by means of cameras borne by small entities (e.g. individual people).

Sousveillance is often associated with grassroots, individualistic activity. It is particularly implemented in conjunction with small mobile devices such as smartphones, electronic seeing-aids, and personal safety devices [1]. Sousveillance has become a significant topic with recent advancements in wearable computing and AR (augmented or augmented reality) [1], [4], [7], [8].

II. DISTINGUISHING AND CLASSIFYING VEILLANCE

This paper presents a theoretical, physical, and mathematical framework for veillance which can be used to precisely define surveillance and sousveillance as well as their commonality and their distinction.

This framework gives rise to a particular definition of surveillance and sousveillance which we call the “*Spatial Jurisdiction*” theory.

For completeness, we include several other potential theories and definitions, each forming their own distinction between surveillance and sousveillance. Spatial Jurisdiction theory is the one which lends itself well to precise mathematical measurement and analysis.

- **Spatial Jurisdiction**, the main focus, to be defined precisely and mathematically quantified in sections III-A and III-B. In essence, surveillance is the gathering of information from sensors or processes within the user’s property or where the user is in a position of control. Sousveillance gathers information from spatially *outside* the user’s region of authority, political or forceful control.
- **Mounting** theory: surveillance cameras are “archicentric”, i.e. mounted to inanimate objects, e.g. land (by way of lamp posts or poles) or buildings; sousveillance cameras are “human-centric”, i.e. borne by people.
- **“Ladder”** theory: surveillance is done only by persons from high positions of authority; sousveillance is done by persons in low positions of authority.
- **Authority Exclusivity** definition: surveillance is the veillance which prohibits other veillances; sousveillance is the veillance which is agnostic toward other veillances;
- **Participant** definition: Surveillance is the capture or recording of an activity by a non-participant in the activity; sousveillance is the capture or recording of an activity by a participant in the activity;
- **Large Entity / Small Entity**: surveillance is practiced by large organizations, corporations or governments; sousveillance by small entities or individuals.

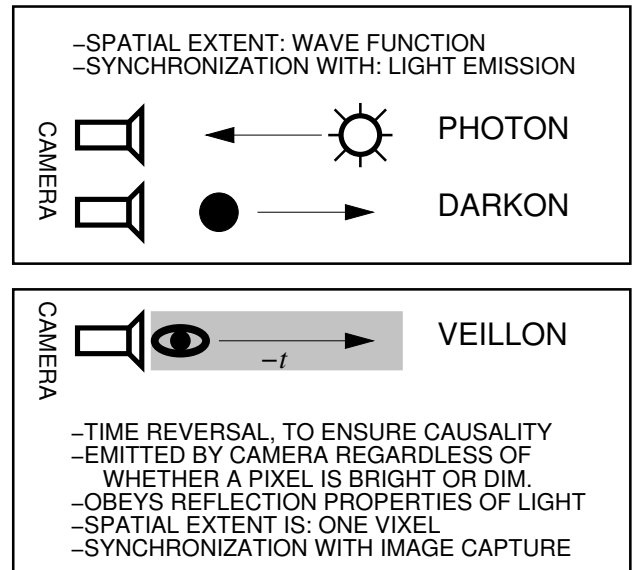

Fig. 3. Veillon, defined to be emitted once for each time-sampling, for each pixel in a camera. The veillon propagates and reflects according to the same optical properties of light, in reverse time, regardless of whether each pixel is sensing a high or low (or even zero) light value.

III. QUANTIFYING VEILLANCE: VIXELS, VEILLANCE VECTOR FIELD, AND SPATIAL JURISDICTION THEORY

This section will provide the theoretical background used to develop the Spatial Jurisdiction theory and definitions of veillance.

While being ubiquitous, electronic veillance takes on many different forms, differing by hardware device, resolution, placement, jurisdictional control, intended purpose, and actual destination of the data.

We aim to provide a simple measurement of surveillance and sousveillance in a space.

Surveillance and sousveillance carry sociological and political connotations, and are understood in the context of human relationships. A mathematical accounting of the amount of veillance would benefit first by a more general understanding of “watching”, by taking the “sur” out of surveillance and “sous” out of sousveillance.

Veillance itself is an action of deliberate observation, regardless of motive, political affiliation, or societal empowerment or disempowerment. We aim to measure veillance neutrally. While veillance can occur in a variety of sensory modalities, we will focus especially on optical veillance.

Typically in optics, light is traced along its pathway from its source, such as a light bulb, laser, or the sun, to its final destination before being absorbed, following along the path of any reflections, refractions or diffractions along the way. Ray tracing accounts for light along its pathway.

For veillance, though, we will trace light ray pathways in the reverse direction to account for optical observation. This reversal was found in the ancient *extramission theory* described by Plato and Ptolemy, of light consisting of rays

from the eyes [10], [11]. Ray tracing in computer graphics also makes use of reverse-tracing of light. In terms of particles this is also analogous to photons vs. “darkons”, i.e. particles of light vs. a lack of light which flows in the reverse direction to the actual light. Electric charges have a similar analogy: electrons v.s. holes. An electron is a carrier of negative electric charge or current, whereas a hole is the absence of an electron: a positively-charged, non-existent, virtual carrier of positive current. Holes were proposed in 1931 by Heisenberg and Dirac and have become well-established in the field of semiconductor electronics. More recently, in the case of optics, “darkons” were proposed (initially in jest) as the absence or inverse flow of a photon [12]. Darkons (or strictly-Latin, “scotons”) are to photons as holes are to electrons. See Table II.

(Darkons have limitations in relativistic situations or astronomical distances, in that they violate causality when they reverse time-of-flight from transmission to reception. However, in most useful everyday situations on Earth, time-of-flight and relativistic effects are negligible.)

More significantly, in the case of veillance, darkons have a key disadvantage: Even if darkons are emitted by a camera, they still cannot account for veillance, or the *ability* to see, because a flow of darkons is dependent on the flow of photons. The ability to see should not rise and fall in proportion to the amount of light hitting a sensor pixel, because that pixel’s *purpose* is to sense the presence or absence of light. Just by pointing a camera at an object, you can’t cause the object to emit light. Therefore, the darkon does not fully account for veillance.

We propose a “veillon”, a new entity that accounts for observation, combined with the propagation properties of light.

We define a *veillon* as one quantum of veillance (for one time-sample from one pixel) which is emitted from a camera and radiates in reverse-time, to enforce causality. A veillon propagates away from the camera, following reflections according to optical properties, **independent of whether light is present or not, and independent of the quantity of light received by a pixel sensor**. A veillon is emitted by the camera at the time each sample is read, for each pixel.

We also define a *vixel*, as a spatial region that encloses

Hot (high temperature)	Cold (low temperature)
Heat (energy)	Coldness
Light	Dark
Photon	“Darkon” (English) or “Scoton” (Latin)
Electron	Hole
Pressure	Vacuum (negative gauge pressure)

TABLE II. PHYSICAL QUANTITIES AND THEIR ABSENCES.

In everyday life, “cold” is referred to as if it really existed, e.g. “Please shut the door so you don’t let the cold into the house”, when in fact cold is merely the absence of heat. Likewise, in everyday life, people often refer to a camera using language similar to language used in referring to a gun, i.e. as if the camera were emitting something. Such terminology as “going out on a film shoot”, or “that’s a great shot”, is commonplace vernacular. Therefore, we might also envision “darkons” (or “scotons”) as an absence of photons (indicating the inverse flow of light) analogous to “holes” which are the absence of electrons (indicating the motion of positive electric current).

the extent of observed space, controlling one pixel, or more generally, one linearly independent scalar observation signal. For a camera, a vixel is the spatial region corresponding to one pixel in the image. (Fig. 1)

Measuring the amount of veillance in a room, or on a street, is the goal of this discussion. First, we examine a camera itself.

Veillance emitted from a digital still-image camera can be measured by the number of pixels multiplied by the bit depth of each pixel.

After the emission of veillons from a camera, the veillons can be blurred or scattered, and degeneracy can occur. For example, pointing a camera at a translucent window, which blurs all the pixels together, reduces the useful information-bearing content to fewer vixels, or as little as one vixel.

“Veillance rate”, r_V , therefore, for a video camera, is:

$$r_V = r_F P B / D \quad (1)$$

measured in bits/second, where r_F is the frame rate, P is the number of pixels in each frame, B is the bit depth of each pixel, and D is the degeneracy of each pixel if pixels are blurred, i.e. the number of dependent pixels controlled by each vixel. P/D gives the number of linearly independent pixels, if the optical setup causes uniqueness to be lost between the pixels. (This will be encountered later in Fig. 5.)

Vixel rays (represented along the centroid of vixels) are illustrated in Fig. 1. Vixel rays are analogous to magnetic or electric field lines, and represent the direction of veillance propagation, but without covering the entire 3-dimensional spatial extent of the vixel. As with magnetic or electric field lines, the closer together adjacent vixel rays are, the greater the concentration of pixel resolution at that point.

Therefore, “veillance intensity”, \vec{V} is a vector field that can be defined at every point in space, with its magnitude equal to the density of veillance rays, and its direction everywhere tangential to the veillance rays. Rather than rays (lines with one start point), we now have vectors defined for every point in space. See Fig. 4.

Considering video streaming, this vector field becomes a *veillance intensity rate field*, \vec{v} , measured in units: [bits/m²/s].

Measuring veillance crossing an arbitrary surface can be done using “veillance flux”:

$$\Phi_V = \int_{\Psi} \vec{V}(\vec{r}) \bullet d\vec{S} \quad (2)$$

Veillance rays are converted to the veillance intensity field, \vec{V} , at position \vec{r} . A dot product is composed with normal vectors to the surface, $d\vec{S}$, whose magnitude is proportional to the area of each infinitesimal portion of the surface Ψ . Veillance flux is measured in [vixels].

We will use veillance flux later, in a more sociological perspective on surveillance and sousveillance.

More generally, in the case of more than one vixel with reflections or more than one camera, vixels may overlap. The veillance field becomes a *vector set field*, $\{\vec{V}\}(\vec{r})$, i.e. each point in space has more than one vector, which do not simply

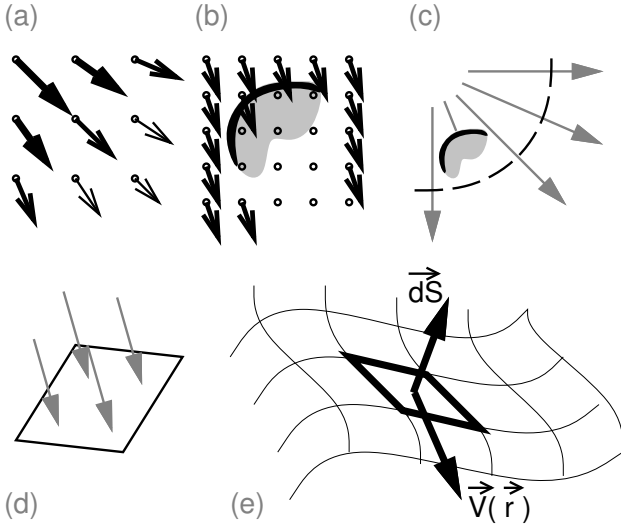

Fig. 4. (a) **Veillance vector field.** The veillance field is defined at each point in space (i.e. a vector field), as opposed to vixel rays which simply trace out the propagation of a veillon. Veillance field intensity at each point is proportional to the density of vixel rays (akin to the density of electric or magnetic field lines). (b) **An opaque object absorbs veillance on its leading edge.** A diffusely-reflective opaque object absorbs the most veillance, because its diffused reflectance causes degeneracy in the reflected veillance rays. That is, from a sensor’s perspective is unclear of the content of anything seen in the reflection (other than the fact that content may be getting brighter or dimmer in total); hence the reduction in veillance (i.e. absorption of veillance) caused by diffused reflection of light. (c) **Vixel rays,** for comparison to the veillance vector field. A vixel is absorbed by an object (i.e. the object is seen), and the remaining vixels are able to continue and pass through an arbitrary boundary line. (d) **3-D:** Veillance impinging a boundary surface in 3-dimensional space. (e) **Veillance flux:** Veillance impinging a more complex surface, broken down element-by-element, in the calculation of veillance flux.

superpose by vector addition because they are associated with different sensors. The veillance flux becomes:

$$\Phi_V = \sum_i \int_{\Psi} \{\vec{V}_i\}(\vec{r}) \cdot d\vec{S} \quad (3)$$

A. The Spatial Jurisdiction Theory of Veillance

Surveillance is often thought of in terms of cameras affixed to property, i.e. real-estate — either buildings (e.g. mounted to inside or outside walls or ceilings), or to land (e.g. mounted to lamp posts, poles, and the like) [1], [4], [5], [6], [7], [8]. In this sense, surveillance is typically an action initiated by a property owner.

Conversely, sousveillance typically occurs when photographing one’s surroundings beyond the scope of one’s property, such as when an individual takes photos in a public garden, or uses a wearable electronic seeing-aid on public property or within another person’s private property.

B. Property Hypersurfaces, for Quantifying Veillance

Using property lines (or more generally, multidimensional surfaces or hypersurfaces) to demarcate between surveillance and sousveillance provides an interesting discussion. By this demarcation, if an individual sets up a camera inside a building s/he owns, and if the vixels are contained within a surface in 3 dimensions enclosing the building’s property, one would be

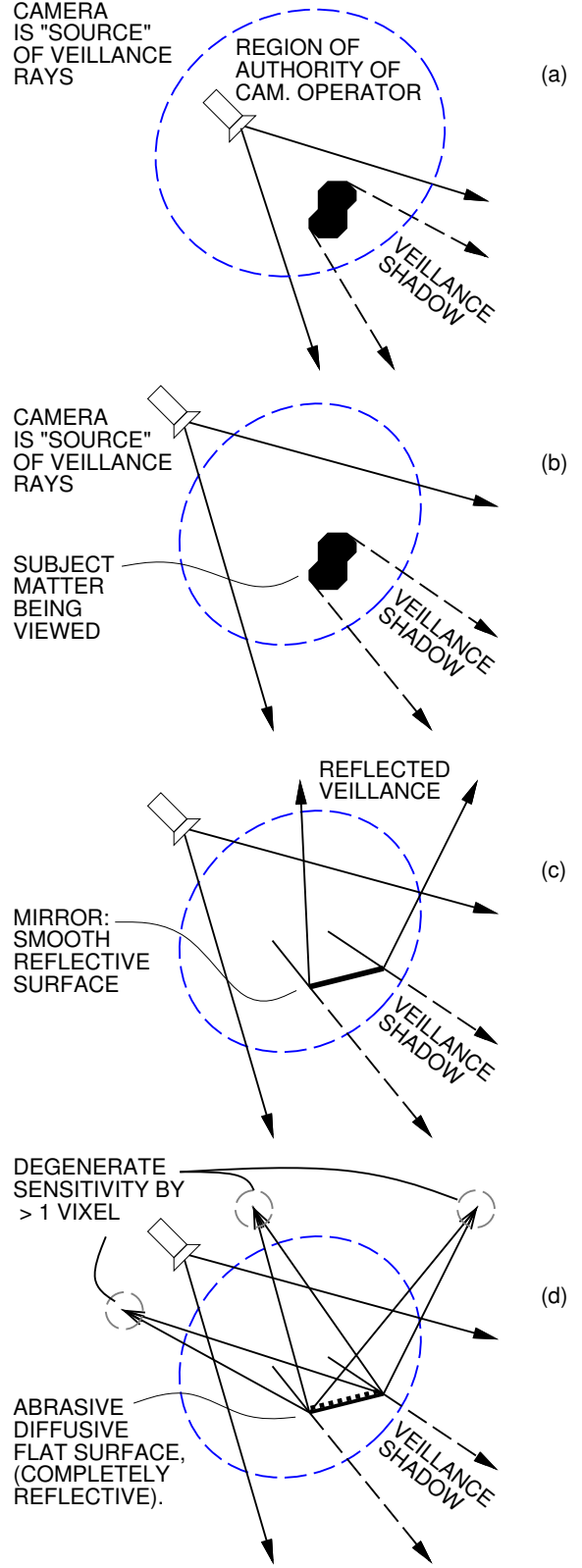

Fig. 5. Veillance rays, impinging a “region of authority” to define surveillance and sousveillance. (a) *Surveillance of an object in the camera-operator’s region of authority;* (b) *Sousveillance by someone outside the region of authority;* (c) *Reflected veillance rays;* (d) *Reduction in veillance by loss of uniqueness of each pixel, from reflection on scattering surface.*

performing surveillance. However, if the camera is pointed to outside the property, onto a public street or to property across the street, the veillance flux through the jurisdiction surface counts as sousveillance.

On a political scale, a king or feudal ruler might conduct surveillance over his peasants, on the streets or inside their houses—everywhere inside his kingdom. That is, his kingdom is his “property”, encompassing many individuals’ properties. For the king, surveillance’s demarcation encompasses a larger area than for the peasants, who might individually keep watch inside or outside their own homes (surveillance v.s. sousveillance). On the other hand, using a telescope to watch outside the kingdom walls, in case a neighbouring kingdom attacks, would be sousveillance from the king’s perspective.

Following this pattern, surveillance and sousveillance are demarcated over progressively larger layers of surfaces, depending on which boundary the veilleur has power, control, or ownership over.

More generally, a “region of authority” is a better descriptor than property because it covers cases when someone enforces sousveillance or surveillance by muscle — legal muscle, or physical muscle enforced in a specific region.¹

See Figs. 5, 6, 7, 8. The region of authority is illustrated in Fig. 6, both in a property sense, and in a corporeal (body) sense. The region of authority is a closed 2-dimensional surface in 3-dimensional space.

Surveillance and sousveillance can thus be immediately quantified by veillance flux crossing this boundary (surface), leading to a simple result in [bits/s].

Veillance within a room, building, property or political jurisdiction can be measured using this method.

Veillance in one region of authority is the total of the veillance flux crossing into a boundary from outside (e.g. 5(b)), plus any sources of veillance emitted by cameras inside:

$$r_{v,R} = \Phi_{vIN,\Psi_R} r_{FB} + e_{v,R} = \sum_{c \text{ outside}} \iint_{\Psi_R} \max(-\vec{v}_c(\vec{r}) \cdot \vec{d}\vec{S}, 0) + \sum_{c \text{ inside}} e_{v,c} \quad (4)$$

Veillance rate, $r_{v,R}$ in a region R (a room, etc.) is thus composed of the veillance flux impinging the boundary Ψ_R and veillance rate emitted $e_{v,c}$ for each camera c inside. The integral is modified to reflect how the property border is a closed two-dimensional surface.

Sousveillance can be quantified by the amount of non-absorbed veillance leaving the region of authority (whether a property line or a region of authority around the human body):

$$r_{\text{sousv},R} = \Phi_{v,\Psi_R} r_{FB} = \sum_{c \text{ inside}} \iint_{\Psi_R} \vec{v}_c(\vec{r}) \cdot \vec{d}\vec{S} \quad (5)$$

This becomes the “sousveillance rate” in [bits/s].

¹A government can conduct surveillance anywhere within their national borders, since the entire national territory falls under a legal, military, communicatory, and economic control of that government, i.e. the “property,” so to speak, of that government.

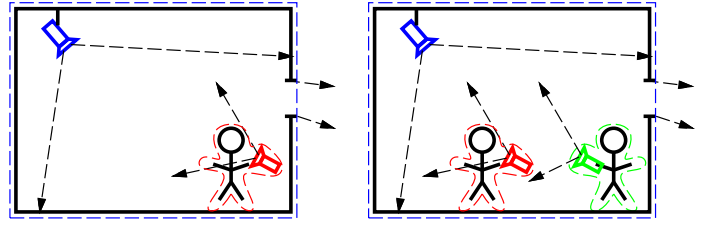

Fig. 6. Veillance in a room, with owner (blue) performing surveillance inside the room, plus a small amount of sousveillance since (blue)’s veillance rays pass outside the blue region of authority. Another individual (red) who is not the owner, nevertheless has ownership of his/her own body—filming oneself is self-surveillance, while veillance rays that leak out behind the corporeal “personal space” create a small amount of sousveillance. When another person (green) points a camera forward, s/he performs sousveillance of the room as all veillans, vixels and vixel rays are able to leave (green)’s corporeal region of authority. We will later analyze the case of reflected, scattered or degenerate vixels, e.g. if there is a mirror in the room.

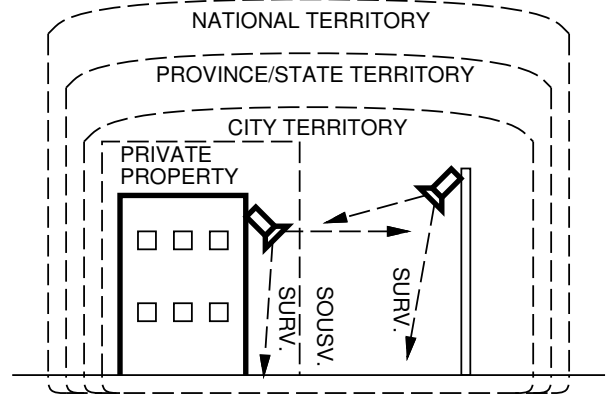

Fig. 7. Layers of property (more generally, regions of authority). Different owners and authorities can place cameras with vixels absorbed (successful veillance of subject matter) on their own territory, others’ territory, or a combination.

C. Real-life scenarios

For example, in Fig. 8(a) two cameras are mounted in a taxi cab, one facing backwards to place the passengers under surveillance, and another camera facing forwards to record what happens through the windshield. The latter is referred to as an “onboard camera” or “dashcam” or “dashcam”. If the passenger-monitoring camera is only 50% blocked by the passenger and interior of the car, then 50% of the vixels escape out the back window contributing to the sousveillance

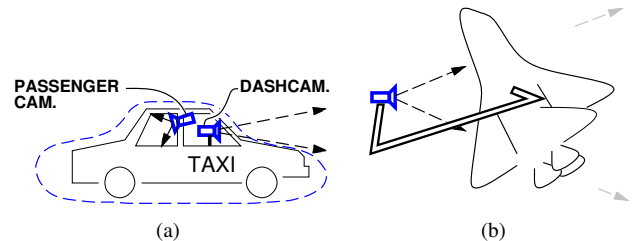

Fig. 8. (a) Both surveillance and sousveillance present in an automobile, such as a taxi cab which has both a passenger camera and a “dashcam”. (b) Space shuttle, using a robotically controlled camera for self-inspection of thermal tiles: both (self-) surveillance and (leakage-) sousveillance.

of the front-facing camera, and if both cameras are standard high-definition 1080p with 24-bit colour at 30 frames/s, the sousveillance rate (viewing the surroundings of the taxi) would be quantified as:

$$r_{\text{sousv.,Taxi}} = \left(\frac{1}{2} + 1\right)(24\text{bits/pixel} \cdot 30\text{frames/s} \cdot 1920 \times 1080\text{pixels/frame}) \quad (6)$$

$$\simeq 2.2\text{Gbit/s}$$

with the calculation simplified by Gauss' divergence theorem, thus creating a measure of the amount of sousveillance emitted by the taxi.

This superposition analysis could thus be performed in a variety of scenarios, from earth to space², if the geometry is known.

IV. DEGENERACY AND UNIQUENESS OF REFLECTED, SCATTERED OR BLURRED VIXELS

Veillance flux and a veillance field were proposed so far, and can be thought of as an aggregate spatial integral of bidirectional reflectance distribution functions (BRDF). Earlier, we reversed the direction in which light is normally understood, so we could develop an **information-bearing** concept of light sensing.

If a camera is pointed at subject matter, the original number of vixels falling on the subject matter may be greater than the number of independent vixels reflected off the subject matter.

For example, if a security camera is pointed exclusively at a stack of cardboard boxes on one side of a room, and meanwhile a burglar is moving on the opposite side of the room, only a small amount of visual information will be available in the vixels falling on the boxes. (i.e. It will likely not be possible to reconstruct the burglar's face just by viewing the boxes, unless the boxes were made of reflective glass instead of cardboard, leading to full vixel reflection.) In the limit of texture roughness, there may be only one effective reflected vixel from each flat face of a box. That is, for a perfectly rough surface, the only extraneous information may be "whether the lights are on" (and how bright), which is all that can be conveyed in one vixel of information.

That is, the reflected veillance from the subject matter may have degeneracy. Degeneracy is used akin to the quantum mechanics term, where one state-observation can be caused by multiple possible states. [13]

With degenerate vixel reflection, diffusion or scattering, multiple possible light sources cannot be distinguished because

²It is illustrative to understand veillance in outer space, as well, for example. Humanity has placed outer space under intense veillance. By looking toward deep space, e.g. trying to sense the cosmic microwave background, this veillance could be said to be sousveillance according to the property definition (planet Earth dwellers viewing their unfamiliar surroundings), since territory ownership in deep space has not clearly been established. (Earth-based property lines can be extended radially outward from the surface of the earth, but eventually become problematic as the earth's self-rotation, solar orbit, and galactic orbit, etc., make radial ownership in a constant state of flux.) Nonetheless, in space, corporeal ownership of one's own human body, or of one's own spaceship, exists just as well as on earth. Thus, as in Fig. 8(b), a spacecraft can perform surveillance of itself; for example, the US space shuttle's practice of inspecting its own heat shields for damage using a camera. Drones, blimps, and spy satellites in orbit are well known for looking down toward Earth and capturing imagery of domestic (surveillance) and foreign (sousveillance) territory.

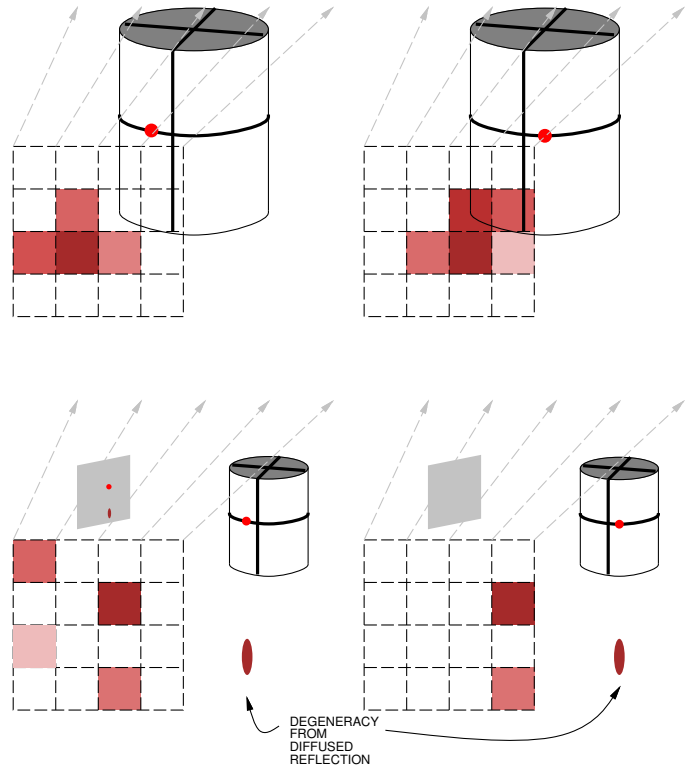

Fig. 9. Testing vixels via an external projected light source such as a laser. Top row: a *large* illuminated area on an object demonstrates the *opposite* test from what we want: It shows which pixels are activated by illuminating an area. Conversely, we want to find the density or number of information-bearing *effective vixels* falling on an object, or impinging a surface. (e.g. property) We first must find the cross-dependency of each vixel, i.e. vixel degeneracy. Bottom row: The illumination area is effectively reduced to smaller than one pixel (by making the camera more distant, or using a finer laser beam). The laser dot is traced across a horizontal track around the object. *Degeneracy* occurs from reflection on the floor and on a mirror, where there is an ambiguity in determining the "system state" from the image alone.

they activate the same dependent set of pixels. As a result, a smaller number of *effective vixels* are reflected, in such a situation of degeneracy. In the extreme, if all pixels are illuminated consistently by all light sources, the result is only one effective vixel of veillance.

One fine point: Even if only one effective vixel is reflected, diffused or scattered, a shadow or projection falling on the subject matter from elsewhere can still cause much more than one vixel of information to be "seen" by the camera, because the shadow or projection is able to independently illuminate multiple vixels directly falling on the subject matter being viewed, before they become scattered. However, after those vixels continue on after passing the subject matter, and become scattered or diffused, the number of effective vixels from the camera "seen" by looking at or through the subject matter is then reduced in the spatial region where those vixels travel next.

We quantify vixel degeneracy in the following section.

V. LASER SCANNING VIXEL PRINCIPAL COMPONENT DENSITY ANALYSIS

To put this theoretical expression into practice, we devised a method for experimentally measuring veillance, in the form

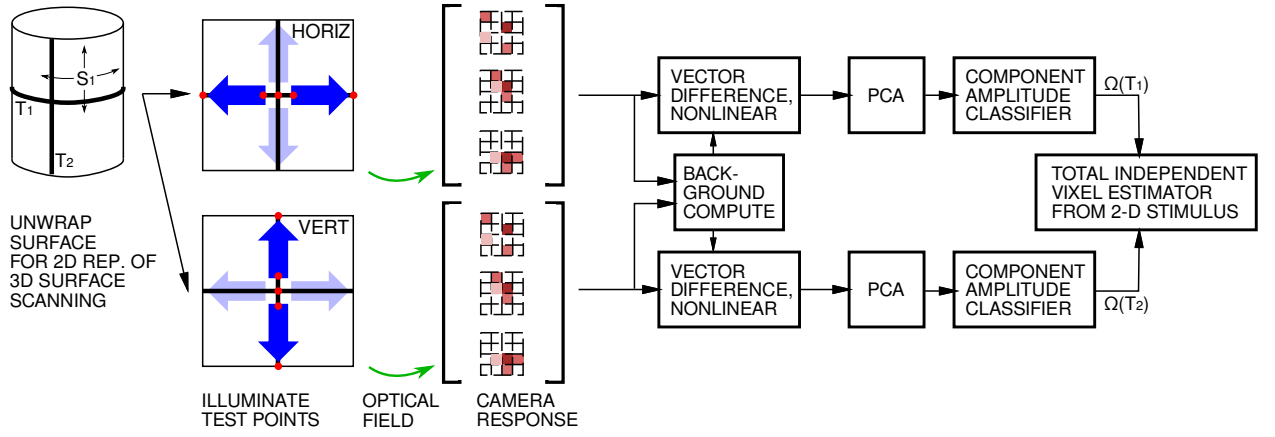

Fig. 10. Laser scanning vixel principal component density analysis.

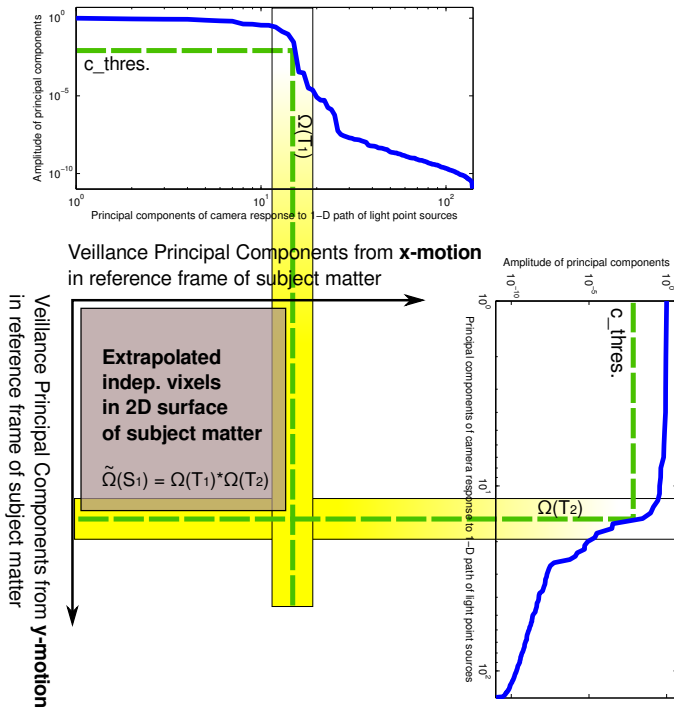

Fig. 11. PCA output as two data sets (for horizontal and vertical scanning with pointwise illumination), to form a metric to estimate the total number of independent vixels, if the entire object’s surface area had been tested point-by-point. This employs the symmetric degeneracy assumption (where we have “fairly” illuminated regions of the object, as opposed to being biased for or against areas close to mirrors, etc.) giving an estimate of vixel independence for the object’s full surface area.

of effective vixels per square metre.

We used principal component analysis (PCA) to identify the number of salient linearly independent (non-degenerate) pixel vectors activated by the light from an object — that is, loosely speaking, the amount of information expressed in the veillance impinging an object’s surface.

We used a laser to scan across the surface of an object or set of objects, while capturing a sequence of images from 1 or more cameras in the room, viewing that subject matter. We chose the size of the laser beam (approx. 1 mm) to cover an area smaller than one vixel (given the camera’s distance

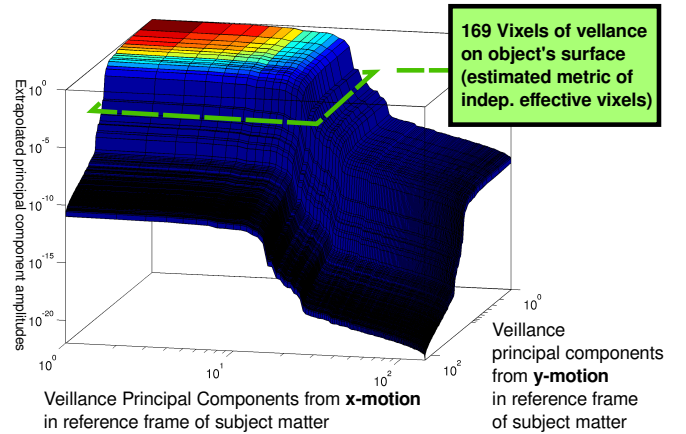

Fig. 12. Metric to estimate the total number of independent vixels falling on an object’s surface area. In cases of symmetric degeneracy (where we have “fairly” illuminated regions of the object, as opposed to avoiding areas close to mirrors, etc.) we combine the measured number of independent vixels across a set of illuminated points, horizontally across an object and vertically, for a total effective vixel metric.

away), to avoid trivial activations of multiple pixels due to its thickness (Fig. 9ab). As a result, we could isolate and identify the various multiple reflections in a room or scene coming from other objects, caused by that light source point (Fig. 9cd).

The camera image vectors from all light source stimuli were background-subtracted, accentuated nonlinearly as $f^4(x, y)_{CAM}$ to cause the high-intensity laser stimulus to dominate over camera noise, and then fed into PCA to identify the number of non-degenerate vixels, and in particular the non-degenerate vixels per unit area of the subject matter’s surface, *not* per unit area from the camera’s perspective.

For each surface segment, S_n , it would be a long process to individually illuminate and test every single point on the surface in two dimensions. However, if we have an isotropic cross-dependency of vixels, we can scan along two orthogonal tracks (T_1 and T_2). The number of significant PCA components, $\Omega\{T_1\}$ and $\Omega\{T_2\}$ are found separately for each track. We can then estimate the extrapolated number of significant PCA components (significant eigenvalues) for the entire surface as:

$$\tilde{\Omega}\{S_1\} = \Omega\{T_1\} \cdot \Omega\{T_2\} \quad (7)$$

$\tilde{\Omega}\{S_1\}$ gives the estimated number of effective vixels impinging the surface — that is, the effective veillance flux (Φ_{VE}).

For the average effective veillance flux density (veillance intensity), in [vixels/m²], we divide by the surface area:

$$\bar{V}_E = \frac{\Phi_{VE}}{S_1} = \frac{\tilde{\Omega}\{S_1\}}{S_1} \quad (8)$$

The veillance rate (effective) for the object’s surface [bits/s], simply uses the bit depth of the camera, B (number of bits for each pixel), and frame rate, r_F :

$$\bar{r}_{VE} = r_F \cdot B \cdot \Phi_{VE} = r_F B \tilde{\Omega}\{S_1\} \quad (9)$$

Thus, we measure $\tilde{\Omega}\{S_n\}$ to quantify the amount of veillance sensing, using the process of “Laser scanning vixel principal component density analysis” which requires:

- **Sufficient number of images/frames:** Sufficient images (or video frames) are needed in the experiment to independently test each hypothesized vixel. Otherwise the PCA components will saturate at the number of video frames. That is, sufficiently many images/video frames are needed to give each potential effective vixel the opportunity to be expressed in a linearly independent vector of pixels.
- **Small test point:** The illumination test point is sufficiently small to spatially access individual physical vixels where they fall on the object’s surface. Otherwise, cross-illumination of independent vixels occurs, similarly to low SNR (signal-to-noise ratio), leading to an artificially low Ω .

See the process in Fig. 10, 11, 12. For example, when a 160x120 pixel surveillance camera was set up in a room, we tested the veillance striking the surface of a door. The veillance on the door surface was measured at 1877 effective vixels per square metre, and the metric reduced in effective vixels per square metre when we placed various translucent materials between the camera and the door.

This process is distinct from measuring plenoptic functions, and BRDF (bidirectional reflectance distribution function) [14], because we are not finding the effect of light rays from arbitrary directions in illuminating subject matter (as used in computer graphics and animation), but instead are finding *the effect of information on each point of an object’s surface, on each pixel of a camera*. Furthermore, we are going beyond a simple input-output mapping, to determine a level of degeneracy in the detected vision of subject matter.

VI. VIXELS IN OTHER SENSING MODALITIES

The concept of vixels also applies to other types of sensors. A building’s temperature-control system might have two temperature sensors, in two separate rooms, creating two vixels of veillance in the building. Those two vixels may overlap slightly based on thermal diffusion between the two rooms. (equivalent to a blurring function in a camera)

In some cases, air or any other fluid can take on a more complex, dynamic motion (either laminar or turbulent motion), such as outdoors in the wind.

In fluid dynamics, the analogue of veillance rays in a fluid flow would be streaklines, as opposed to streamlines and pathlines. Veillance can take place when measuring temperature, chemical content, colour, etc. of the air, or any other fluid, sensing material that has flowed from another location according to laminar or turbulent flow.

For example, an atmospheric pollution sensor set up outdoors would perform veillance with one vixel; the vixel is a region extending outward from the sensor in an irregular or regular conical shape, according to the wind source. If the wind is blowing towards the sensor from the South-East, coming from London, then the sensor is performing veillance on London with one vixel of resolution.

Streaklines follow fluid flow according to each fluid element in time-reversed flow, time-reversed from the intersection with a particular point in space. The difference between streamlines, streaklines and pathlines is subtle [15], and it is interesting that there is a direct analogue to veillance.

VII. HDR (HIGH DYNAMIC RANGE) SENSING, CDR (COMPOSITE DYNAMIC RANGE) SENSING

We developed a method for sensing multiple dynamic ranges simultaneously [16] and an algorithm for compositing dynamic ranges of a waveform [17] into a combined high dynamic range. This initial work was designed for audio, as well as time-varying signals above and below the frequency range of human hearing.

Two configurations of this system, for simultaneous HDR sensing and CDR compositing, are:

1 sensor feeds $M \geq 2$ ADCs	1 vixel
$M \geq 2$ sensors feed M ADCs	Effective vixels: ranging from 1...M Desirably 1 effective vixel

In the latter case, it is desirable for the sensors to be co-located or sensitive to the same spatial location. If the sensors are not perfectly co-located in an acoustic field, acoustic waves will be slightly out of phase or attenuated from one sensor to the next. This discrepancy can be quantified in terms of effective vixels. For two sensor signals x_1 and x_2 , we can define the number of effective vixels as:

$$v_E = 2 - |\rho_{1,2}| = 2 - \frac{|E[(x_1 - \mu_1)(x_2 - \mu_2)]|}{\sigma_1 \sigma_2} \quad (10)$$

using the Pearson correlation coefficient $\rho_{1,2}$, where μ_1 , μ_2 , σ_1 and σ_2 are the mean and standard deviations of x_1 and x_2 , respectively, and E denotes expectation. Here, v_E ranges from 1 to 2.

Empirically, we can test the cross-correlation:

$$v_E = 2 - \frac{\sum_{n=1}^N (x_1(n) - \bar{x}_1)(x_2(n) - \bar{x}_2)}{\sum_{n=1}^N (x_1(n) - \bar{x}_1)^2 \sum_{n=1}^N (x_2(n) - \bar{x}_2)^2} \quad (11)$$

This method requires a test measurement of the sensors in their linear regime, before saturation. This can be evaluated in a temporarily restricted dynamic range, smaller than the full capability of CDR/HDR sensing. More generally, for $M > 1$ inputs, then the number of vixels can be empirically estimated using the PCA method described previously, i.e. estimating v_E from Ω .

A. CDR sampling for aircraft pitot sensors

We extended CDR/HDR audio by creating a system to combine the dynamic ranges of pitot airspeed sensors as used in aircraft. This novel system uses 2 vixels, for application on a typical aircraft with a speed sensor mounted on either side of the cockpit. These two vixels are correlated during ordinary forward-facing aircraft motion, when the forward motion dominates over the atmospheric turbulent flowfield. In this limit, the effective vixel count approaches 1.

We built one configuration using pitot sensors having *different* dynamic ranges, and another with two *identical* pitot tubes, to create resilience against icing conditions where one or both of the sensors may become partly blocked by ice. We devised an algorithm to dynamically detect and adapt to the drifting dynamic range responses of the sensors, if one of them becomes partly blocked or compromised.

VIII. HIR (HIGH IMPEDANCE RANGE) SENSING, CIR (COMPOSITE IMPEDANCE RANGE) SENSING

In this work, we introduce a sensing system which forms a composite signal over a wide range of acoustic or electric impedances.

Impedance governs how waves propagate through a medium.³ If an acoustic wave or electromagnetic signal encounters a change in impedance, then some of the signal energy is not transmitted onward but is instead reflected back. Thus, when a sensor (such as an acoustic pickup) is mismatched to the impedance of the medium (such as solid, liquid, gas), some of the signal will not be picked up; some frequencies will be attenuated by spectral colouring.

Acoustic sensors optimized for states-of-matter include:

Sensor	Imped., Acoustic	Sensitive to:
geophone	high ($Z = p/v$)	vibrations in solid matter
hydrophone	medium	vibrations in liquid matter
microphone	low	vibrations in gaseous matter

We built a composite-impedance-range transducer, using a coupled geophone, hydrophone and microphone, and fed the three signals into a computer where they were composited into a CIR output signal. An example of the three-impedance outputs are in Fig. 13. Unlike the CDR case (composited dynamic ranges) where spatial separation of sensors may cause the vixel count to exceed its ideal value of 1, in CIR, spectral colouring by impedance mismatch can further differentiate vixels. Each sensor m has a transfer function $H_m(f)$ describing its response in the frequency domain. The number of effective vixels can be defined by scanning this spectral response, and for two sensors, co-located and immersed in the same medium, v_E can be defined analogously to the correlation coefficient:

$$v_E = 2 - \frac{\int (H_1(f) - \bar{H}_1)(H_2(f) - \bar{H}_2)df}{\int |H_1(f) - \bar{H}_1|^2 df \cdot \int |H_2(f) - \bar{H}_2|^2 df} \quad (12)$$

³For acoustic signals, impedance governs the ratio of pressure to velocity in a wave. For electric signals, impedance in a medium governs the ratio of voltage to current.

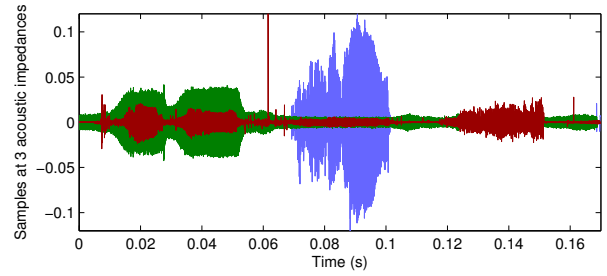

Fig. 13. High Impedance Range (HIR) sensing, using three physical vixels, each optimized to sense wave propagation in a different acoustic impedance. The green, blue and red traces are responses from solid, liquid, and gas-acoustic-impedance sensors, respectively, to a 200 Hz tone, when the HIR apparatus is immersed or contacted in sequence in each media which have been excited by the 200 Hz tone: oscillating stainless steel, water, and air.

Applications of HIR and CIR sampling include:

- Sensing sound generation/propagation in multiphase media, or media in which the phase is not known in advance;
- Sensing sound in different chemical compounds, across a continuum of acoustic impedances.

IX. CONCLUSIONS

We have developed a simple physical and mathematical framework for quantifying veillance, in terms of vixels, veillance intensity rate field, and veillance flux, which, when crossing borders (surfaces) of authority, can measure the relative amounts of surveillance and sousveillance. We have extended this concept to new sensing systems: composite dynamic range sensing and composite impedance range sensing. In summary, we have suggested that veillance can be a precisely measurable phenomenon, both by physical properties and by its social context.

REFERENCES

- [1] S. Mann, "Sousveillance, not just surveillance, in response to terrorism," *Metal and Flesh*, vol. 6, no. 1, pp. 1–8, 2002.
- [2] —, "Sousveillance: inverse surveillance in multimedia imaging," in *Proceedings of the 12th annual ACM international conference on Multimedia*. ACM, 2004, pp. 620–627.
- [3] K. Dennis, "Viewpoint: Keeping a close watch—the rise of self-surveillance and the threat of digital exposure," *The Sociological Review*, vol. 56, no. 3, pp. 347–357, 2008.
- [4] K. Michael and M. Michael, "Sousveillance and point of view technologies in law enforcement: An overview," 2012.
- [5] J. Bradwell and K. Michael, "Security workshop brings 'sousveillance' under the microscope," 2012.
- [6] G. Fletcher, M. Griffiths, and M. Kutar, "A day in the digital life: a preliminary sousveillance study," *SSRN*, http://papers.ssrn.com/sol3/papers.cfm?abstract_id=1923629, September 7, 2011.
- [7] C. Reynolds, "Negative sousveillance," *First International Conference of the International Association for Computing and Philosophy (IA-CAP11)*, pp. 306 – 309, July 4 - 6, 2011, Aarhus, Denmark.
- [8] V. Bakir, *Sousveillance, media and strategic political communication: Iraq, USA, UK*. Continuum International Publishing Group, 2010.
- [9] S. Mann and P. Wassell, *Proposed law on sousveillance RESOLUTION: 000001 (MANN-WASSELL LAW)*. <http://www.webcitation.org/6DGWgAmau>, 2012.

- [10] G. T. Doesschate, "Oxford and the revival of optics in the thirteenth century," *Vision Research*, vol. 1, pp. 313–342, 1962.
- [11] G. A. Winer, J. E. Cottrell, V. Gregg, J. S. Fournier, and L. A. Bica, "Fundamentally misunderstanding visual perception: Adults' beliefs in visual emissions," *American Psychologist*, vol. 57, pp. 417–424, 2002.
- [12] S. Mann, "Theory of darkness (an april fool's research paper)," *MIT E15-389*, 1995.
- [13] A. French and E. Taylor, *An Introduction to Quantum Physics*. MIT / W.W. Norton & Company, 1978.
- [14] F. Nicodemus, "Directional reflectance and emissivity of an opaque surface," *Applied Optics*, vol. 4 (7), p. 767775, 1965.
- [15] P. Kundu and I. Cohen, *Fluid Mechanics*. Academic Press, 2008.
- [16] S. Mann, R. Janzen, and T. Hobson, "Multisensor broadband high dynamic range sensing..." in *Proc. Tangible and Embedded Interaction (TEI 2011)*, 2011, pp. 21–24.
- [17] R. Janzen and S. Mann, "High dynamic range simultaneous signal compositing, applied to audio," in *Proc. IEEE CCECE 2012, Montreal*, April 29 to May 2 2012.